

LANCAIR[®]



DESIGNED TO MOTIVATE



HISTORY

The Lancair was first made available in 1985. At that time, and unlike many designs on the kit plane market, it had already gone through a one year test program in which many refinements were made.

The design philosophy was to stress simplicity in what is a relatively complex high performance aircraft. Due to aerodynamic and pure styling considerations, the only suitable materials were composite. Until this date, the only composite airframes on the emerging kit plane market were standard room temperature, wet lay up systems — a derivative from common “boat technology”. From the beginning, these materials were not suitable for the Lancair’s goals of high material standards, repeatable quality assurance and airframe longevity. Thus Lancair became the first kit plane to use 100% high temperature epoxy based, advanced composites throughout its primary structural airframe.

Combining what is perhaps the ideal set of flight characteristics, performance and h.p. ranges for the 1990’s along with clearly superior airframe materials, a very complete kit and styling that is second to none, Lancair quickly earned the title as the best selling high

performance kit plane in the entire world! A title it had earned by 1986. In fact, in 1987, more Lancairs were sold than any model of single engine piston production aircraft in the world!

This strong acceptance and sales basis has helped to create a profitable and solid company foundation from which tremendous testing, research and development is constantly emerging. With both the Lancair 235 and the new Lancair 320, finite element analysis has been conducted on all major airframe components making it one of the most analyzed airframes among all kit planes.

The new Lancair 320 benefited heartily from that continued research and development emphasis. The “320” has quickly been recognized as a new and very exciting thoroughbred that is refined from the ground up to be sensational.

“Expect it to be a sensation”

Jack Cox, Sport Aviation Magazine

"Best selling high performance kit plane in the world".

And with the Lancair 320, we've made that world title holder *even better.*



LANCAIR'S WINNING FEATURES

INTRODUCTION

One of the primary goals of the Lancair was speed, speed with as little h.p. as necessary. It is very easy to achieve high speeds by simply adding more and more gas guzzling h.p. but that is too inefficient and most importantly too expensive for daily, pure pleasure operation.

Thus the Lancair began on the drawing boards as a very sleek design with no sharp corners, only smooth curved surfaces. Wetted area was kept to a minimum while cockpit area was totally maximized. The landing gear could only be fully retractable which offers the best of both worlds: the introduction of drag when you want it for approaches and landings and the total elimination of drag during cruise. The gear tucks up into the wing leaving absolutely *no* bumps or blisters to cause drag.

Aluminum structure was not suitable to the compound curves used throughout the entire airframe. Also, aluminum structures are extremely labor intensive and require many jigs to properly align parts which in itself is additionally very time consuming. The tools required of aluminum structures are quite complex as is the experience necessary to properly rivet, buck and fit aluminum panels.



In comparison, composites offer fully premolded components of virtually any shape required. Building times are reduced significantly, tool requirements are less demanding and most importantly, builder mistakes can almost always be easily repaired thus saving the part. With aluminum, you would have to throw the part away and start over if a mistake were made.

Reparability is also superior with composites. Composite components are much more impact resistant and usually punctures or "hangar rash" will be limited to just the areas of impact which can then be quickly and easily field repaired. Aluminum structures can't easily be twisted, requiring an entire wing rebuild from a simple tip strike. In addition, composites will not rust, rot, or corrode and they have a much better fatigue life. With composite's high bending strengths, less ribs and bulkheads are required which further reduces building complexity. The only weak points for composites have been ultra violet degradation and heat. UV can easily be blocked out by virtually any good quality paint, also primers with UV barrier are readily available but it is now commonly accepted that a good quality paint pigment will sufficiently block UV. Heat related problems which affect strength and longevity are virtually eliminated by today's epoxy based, high temperature advanced composites from which the entire Lancair airframe is composed.

The Lancair advanced composite airframe is truly "state of the art" and offers smooth surfaces that no other airframe medium can produce. This further reduces surface drag and helps to explain the tremendous performance of the Lancairs.

The Lancair fuselage has been likened to a "work of art", a fact of which we're particularly proud. Only in composites could a fuselage like this be possible. In fact, we're amazed that any maker would today design a "slab sided" fuselage out of composites, yet some do.

MATCHED OVERLAP, DOUBLE JOGGLE SYSTEM

Our approach to the assembly of the Lancair is purely one of *simplicity*. The Lancair is designed for the first time builder, in fact a major percentage of our customers are first time builders.

Our unique matched overlap, double joggle system used on the Lancair components offers something that none of our competitors can offer — speed of assembly. This system practically aligns the parts for you with a lap joint that is mated below surface so that when the bonding plies are added, the resultant joint will be flush to the surface. This joint system is also uniquely strong, with total bond joint duplication for excess strength and assured safety.

JOINT LINE CROSS SECTION

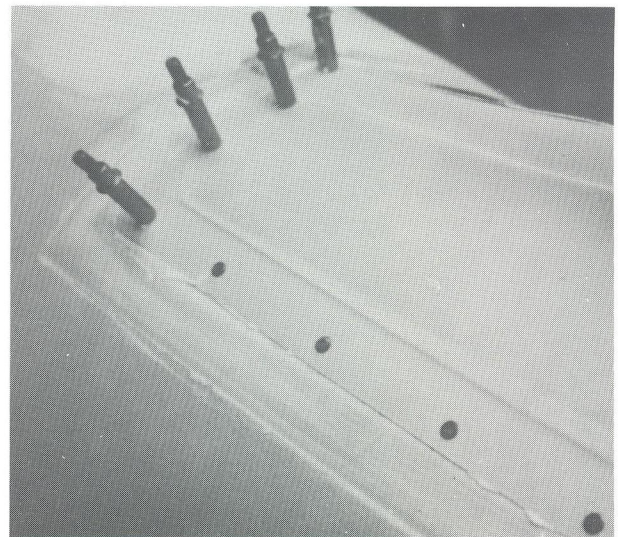
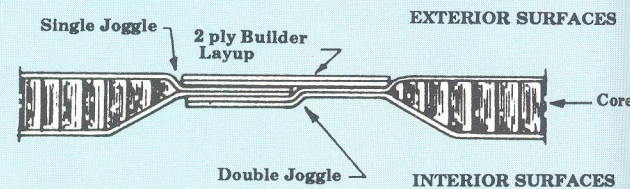

Lancair's vertical fin aligns into the unique double joggle.

THE FUSELAGE

The Lancair fuselage is in two primary halves. These halves are mated together with the double joggle lap joint along the center line. No jigs are required, just three saw horses! The fuselage can be clipped together in literally twenty minutes! As with all double joggle lap joints, a special structural adhesive is used as the primary bond. This structural adhesive has a shear strength of over 2,000 psi, far in excess of the required bond strength. But there is still an additional epoxy/fiberglass "tape" bond which is applied over these joints thus providing additional strength to all joints.

For easy installation of all systems, the canopy and frame are always removeable as is the forward deck. This allows open, unobstructed access to everything from the cockpit to the engine compartment, a feature you'll grow to appreciate as you build in the systems. It is also a feature not available from our nearest competitor!

Also, the rear vertical fin is a separate part which allows for tail cone access during installations of controls, antennas, etc. This feature is also unavailable with the competition. When all systems are installed, you then close out the vertical fin and dorsal fin components. And that's a builder friendly design approach!

Our one piece canopy is thicker with low angularity for strike protection while affording nothing short of spectacular visibility. It is also easily mounted from the *inside* which greatly enhances safety since plexiglass is difficult to bond to and the resultant loads during high speed flight could break the bond causing part failure. This has occurred more than once on other types of kit planes with externally mounted windows.



"Ultra sleek, top performance reality"

Don Dwiggins, Plane & Pilot Magazine

THE WING:

Lancair uses one of NASA's recent airfoil designs, the Natural Laminar Flow NLF-0215-F. This airfoil produces up to 30% less drag than other airfoils used on production aircraft and high performance kit planes such as Falcos, RVs and Glasairs. Lancair's NLF airfoil produces a higher lift coefficient as well. The result is less wing area required, less induced drag, less parasite drag and superior performance. Yet it is not a "critical" airfoil which means that with bug and rain contamination, lift will not be lost, drag will merely increase somewhat. Critical airfoils are acceptable for specialty applications such as short duration racing planes etc. but totally unacceptable for general aviation, cross country aircraft where bugs, rain and paint chipping are everyday occurrences.

There is no magic in achieving outstanding performance, one must simply reduce drag. When starting with a low drag, high lift airfoil, the challenge becomes reachable without resorting to ridiculous amounts of inefficient horse power like some of our competitors have done. That is to say, less efficient wings require more area to lift the plane which increases drag requiring more horse power and more fuel capacity which increases weight thus requiring more wing area. . . .and so it goes.

AIRFOIL DRAG COMPARISON

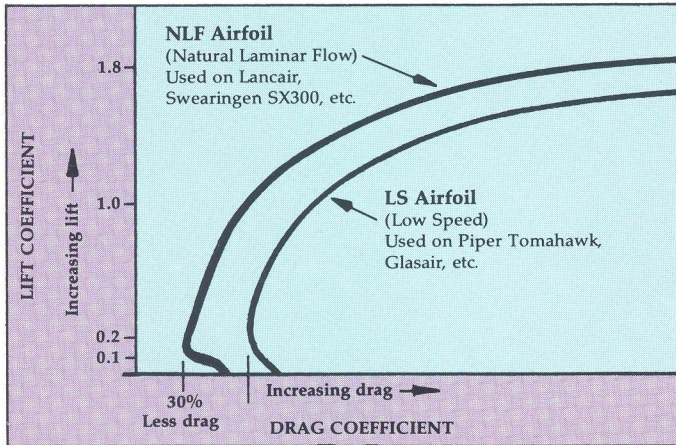

The Lancair wing is a mere 76 sq. ft. of aerodynamic efficiency. This is possible due to not only the airfoil section used but also because of the airframe materials used. Our epoxy based high temperature advanced composites produce a **9G airframe that is over 25% lighter** than our nearest competitor's wet lay up airframe. That allows for a reduced gross weight and thus less wing area requirements. Wing aspect ratios are also important. Lancair's AR is 7.2 which provides excellent efficiency, far better than our competition's 6.6 and is yet another reason why Lancair is so efficient.

S = 76 sq ft
AR = 7.2
Wing Area = 76 sq ft
Wing Span = 23.27 ft
Wing Chord = 3.24 ft

Wing loading on our new Lancair 320 is an ideal 22.17 lbs/sq.ft. It is generally considered that wing loadings above 25 will often result in difficult handling qualities particularly in adverse or emergency conditions and short fields can be challenging to say the least. Yet wing loadings of less than about 16 lbs/sq.ft. will not provide a smooth enough ride for extended cross country flying. Our Lancairs all have wing loadings from 18.42 (model 235) to 22.17 (model 320) which are ideal. The new 320 takes the bumps like the thoroughbred it is.

WING LOADING (affects on handling and ride)

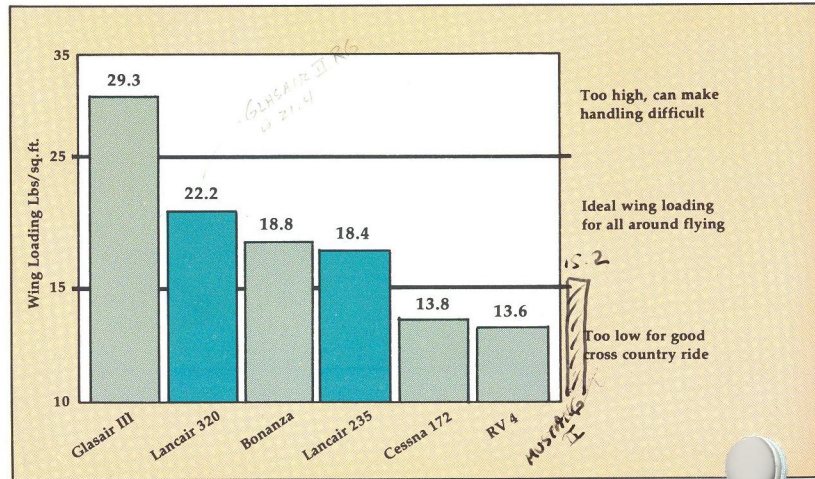

Neico Aviation's approach to the Lancair wing assembly is another fine point. Until the Lancair, all composite shell wings were bonded with a "butt" joint at the leading edge. That approach is quite intolerant of builder errors and was therefore determined by Neico Aviation to be an unsuitable assembly technique. With great difficulty, Neico, in conjunction with High Tech Composites Inc., developed a totally unique assembly approach.

With any wing, the maximum loads are generally dispersed along the forward 25% of the chord placing the greatest strain on that forward section. The unique Lancair wing has a continuous forward "D" section which represents that forward 25% of chord. This section comes as one already complete unit and is part of the upper wing skin.

Lancair inboard wing skins also come to the builder with a reinforced "wing walk" area already applied.

Wing tips on the new Lancair 320 have drag reducing Hoerner type tip designs which sweep upward. They also incorporate an outward sweep which further reduced wing tip vortices thus further reducing drag. Flush mounted position lighting is now also available.

gross wt stall (235)

CL	V _{eps}	V _{mph}
1.5	101.6	69
1.6	98.4	67
1.7	95.1	65
1.8	92.8	63

Model 235
Wing Area = 76 sq ft
Wing Span = 23.27 ft
Wing Chord = 3.24 ft

And finally, the Lancair outboard wing sections are fully removable. This is quite complex from an engineering standpoint but exceptionally easy from a builder/owner standpoint. The outboard 7.5 ft. of each wing is removable which leaves the plane fully on its tricycle retractable gear and just 100 inches wide. With trailering limits in most states of 8'6" or 102", trailering is easy. And there are no hydraulic lines to disconnect. Wing sections can be easily removed in as little as fifteen minutes per side depending on what you have installed in the outboard wing sections (antennas, auto pilot servo, etc.). There are two primary attach bolts, one is reached from the outboard end of the gear well and one inboard just in front of the seats. It's simple, quick and strong having been load tested to 9 G's.

We feel removable wings are a huge advantage from a utility standpoint allowing very easy trailerability to and from the airport. Although not designed for daily trailering, it makes it simple to transport your newly finished plane to the airport or to take your plane home for a week, a month or a winter to perform routine maintenance. Yes there is a slight weight penalty for this convenience but our advanced composite E-glass and graphite wing is *still* over 25% lighter than our competition's wing which does not have removable sections and requires messy hydraulic disconnections for trailering all of which makes ground transporting extremely difficult. In contrast, your Lancair will be very easy to trailer.

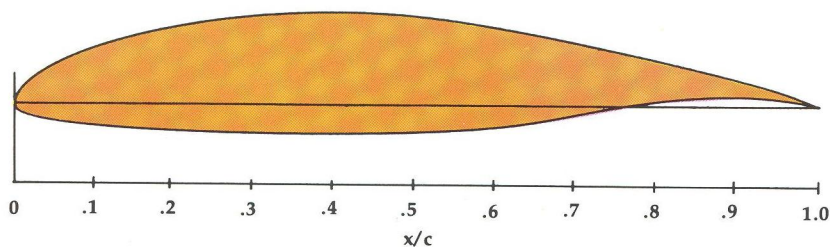

NLF(1)-0215F airfoil (a) $f=0^\circ$.

THE CABIN — DELUXE COMFORT

The Lancair boasts one of the largest cabin areas of any two seat high performance kit plane. Although the Lancair may seem small, it is incredibly roomy since this was one of the primary design goals. With a horizontal cabin width of 42.7 inches on our new Lancair 320, it is as large as a Bonanza, wider than a Mooney! Seating is very comfortable with a seat back angle that can be tailored to suit the individual builder. Seat back angles are suggested at between 24° and 29°'s. Another prime comfort factor with the Lancair is the lack of a forward wing section carry through. With other kit planes, the forward wing section runs through the entire cockpit thus interfering with your leg room. You must lay your legs over this wing section and many pilots complain about leg fatigue and loss of circulation from that seating restraint. With the Lancair, leg room is unrestricted. You can fly with your legs extended out to the rudder pedals or bend your knees and bring your legs up, the instrument panel is also carefully positioned to not interfere.

Panel space is also deluxe with plenty of room for complete IFR with auto pilot. Our optional premolded fiberglass panel has multiple levels which conveniently break up the monotony of an all flat panel and also help with systems grouping by providing definable space for flight instrument, radio/navigation equipment and engine monitoring gauges.

Instrument panel service access was also of prime importance. This is an area where most designers pay little attention thus you, the builder, end up laying on your back for hours trying to install instruments and/or service them. With the Lancair, that problem is eliminated forever! Remove the dust cover and the whole back of the panel is totally accessible from side to side. Remove the forward deck (optionally made removeable) and literally *everything* from panel to firewall is opened up for service, avionics checks, etc. etc. Once you've installed a panel, you'll understand the tremendous value of this feature. And it's a feature that's not available with the competition.

A convenient glove box is also possible on all Lancairs. It locates in the center console, is easy to install and very practical. Plans also show how to install adjustable rudder pedal assemblies for various sized pilots.

Custom premolded instrument panel, molded glare shield, Teak control stick handles, avionics, auto pilots, instrumentation . . . it's all in our growing catalog of options and accessories.



LANCAIR 320 CABIN AREA

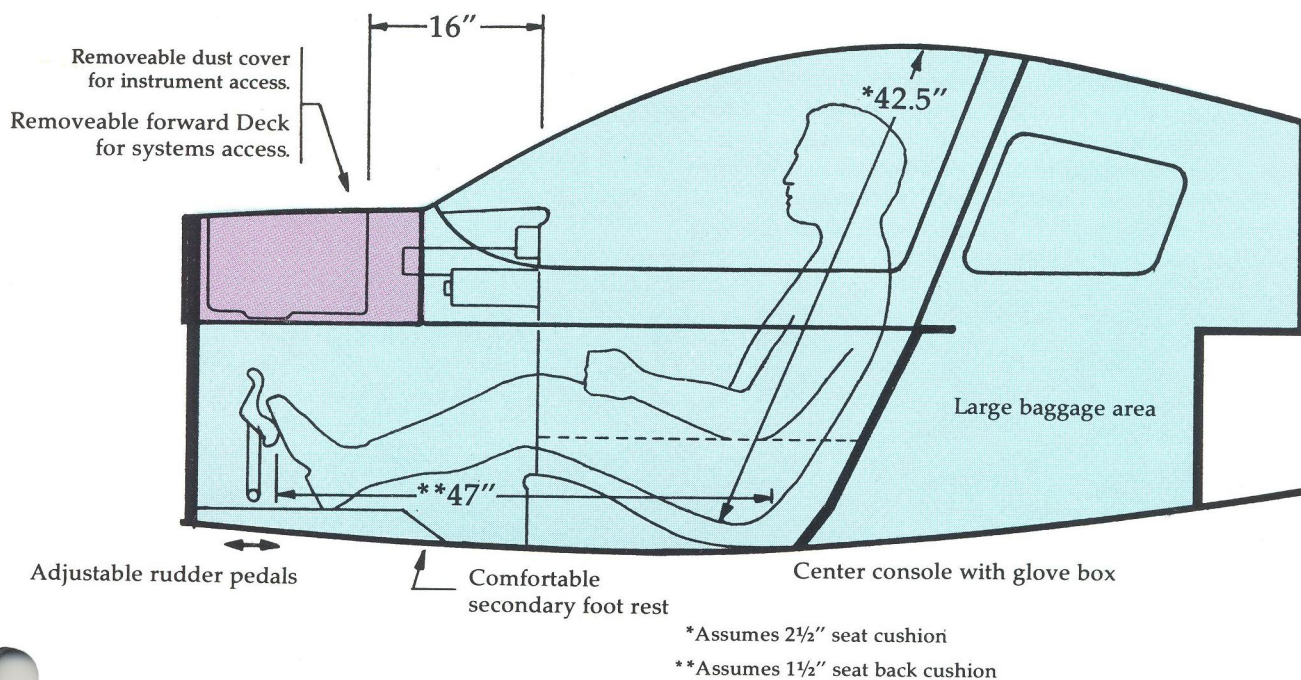

Entry into the roomy cabin is made easy by Lancair's unique parallelogram canopy system. When opened, a full 24" of unobstructed access is available across the entire cockpit. Spring loading makes the canopy move with finger tip ease. An optional forward hinged canopy arrangement is also being developed. The one piece canopy offers totally unrestricted visibility which is normally only seen on military fighters. Our model 320 offers a thicker canopy (optional on model 235's) and all have a low angular attack to deflect blows and minimize strike damage which is statistically of minimal concern on a tractor type (propeller in the front) aircraft design. The canopy is held down with four corner latches that individually possess a 200% safety margin each. In addition, the canopy frame incorporates a rear roll over bulkhead to match the fuselage roll over bulkhead just behind the cabin area.

THE CONTROL SYSTEMS — SMOOTH AS SILK

Once again, control systems are designed for builder ease. They are easily inspectable, easily removeable, designed for long service life and smooth control. Ailerons and elevators are all on push pull tube systems with bearing mounts and rod end bearing ends for silky smooth control inputs. Flying the Lancair has been compared to flying the Airforce T-38 jet with light, quick and stable controls.

Rudder control is via stainless steel cable, flaps are fully electric so there is no arm wrestling in the cockpit as you round the pattern, simply press the switch and you'll get what you need. The linear actuator comes with its own custom micro switch assembly that mounts directly to the actuator arm — again, we make it simple for you. From there the flap motor drives push pull tubes on rod end bearings to the flaps. Flap travel is from a cruise position of -7° 's to a $+45^{\circ}$'s for landing (320 model only, the 235 model incorporates $+25^{\circ}$'s down.)

All control systems are fully supplied and machined. There are a few flat pieces and attach brackets to be made from supplied stock or an optional "Builder Hardware" set can be ordered which has all required parts premade and anodized.

AILERON CROSS SECTION

INBD END

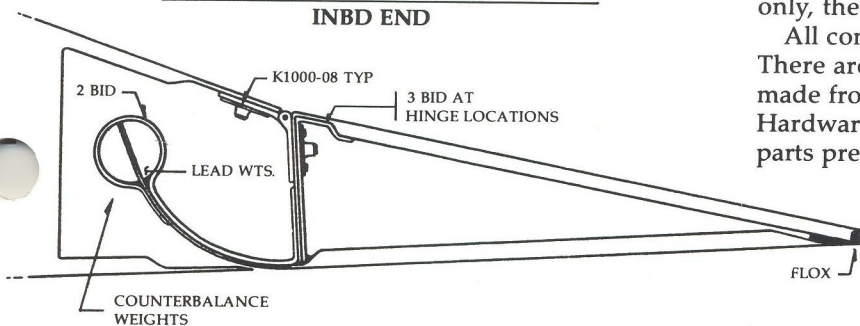

THE LANDING GEAR — FUNCTIONAL SIMPLICITY

All Lancair models come with fully retractable landing gear. This gear is custom and designed for simplicity. The main gear is of the "trailing arm design" similar to that used so effectively on all the Mooney aircraft. This design approach offers simplicity of parts and maintenance along with excellent handling properties. On model 235's, the nose gear is of this same trailing arm design. On model 320's, due to its increased weight and the relatively short wheel track, a totally new oleo type nose strut has been developed. An exhaustive testing program was made with the resultant strut possessing the latest military type dampening materials and design. This design is the first to reach the kit plane market and is far superior to older type friction dampeners. It is also superior to external piston type viscous shimmy dampeners in that it is *totally* internal and there are no seals exposed to dirt and grit which would reduce service life. We are particularly proud of this new technology once again finding its way into the kit plane market via the Lancair.

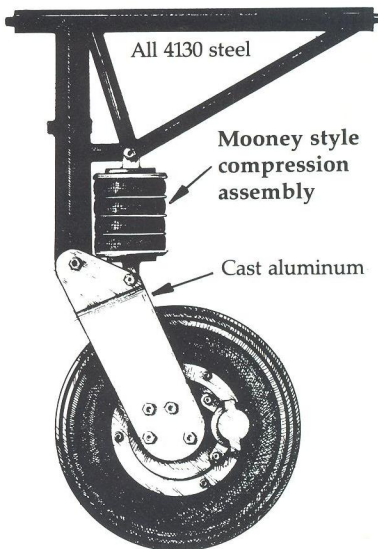

The gear system comes to you completely machined and ready to bolt into position. All electrical systems, pump, relays, indicator lights, pressure switches etc. are included except for the connecting wire, circuit breaker and hydraulic fluid.

Steering is accomplished by differential braking of the main gear. The nose strut is castering. This is very easy to master and allows for extremely tight turns during taxi. The Lancair will literally turn within its own wing span.

The gear is fully electric/hydraulically actuated. Flip a safety locking switch and in seven seconds the gear will be fully tucked up into the gear wells. There are complete gear door enclosures resulting in absolutely NO openings OR blisters under the wing. An optional hydraulic gear door closure system is available which eliminates adjustments, is independent of the gear thus allowing the gear leg to flex under G loads without opening the gear doors. As a safety feature, the gear is held up by hydraulic pressure alone thus there are no up locks which could jam and prevent the gear from locking down. With electrical failure of any type, simply open the "dump valve" and the gear will actually drop down and lock *faster* than if you had pumped it down! A 100 lb gas strut assures that the nose gear will lock down and dual springs assure that the mains will do the same. The gear wells are designed such that if the gear goes in it will never jam when dropping down. In all the thousands of flight hours logged on Lancairs, there has *never* been a case where the gear would not come down and lock!



Wheels and brakes are made by Rosenhan expressly for the Lancair. This brake system uses commonly available Cleveland brake discs for easy replacement but their unique design allows for a slimmer profile thus allowing for *total* retraction into the gear well without *any* gear door "blisters" which would generate drag.

Tires used are Lamb tires all around. For the model 320, eight ply tires are used on the main gear with 6 ply on the nose, the model 235 uses 6 ply all around. These tires look similar to a standard 500 x 5 but have a slightly smaller profile. The Lancair is not suitable for "rough" fields. Fields should be good grass or gravel as a minimum. It has been found that these Lamb tires provide nearly as much access to unpaved runways as 500 x 5's.

EXTENSIVE AIRFRAME TESTING

Mr. Martin Hollmann, A.E. of Aircraft Design Inc., has independently conducted all primary structural design engineering. Mr. Hollmann is considered to be one of the foremost experts in advanced composite technology in the world. He works closely with NASA and has helped to develop the best computer analysis programming for hybrid composite structures.

STRUCTURAL TESTING

The Lancair has thus become one of, if not *the* most, analyzed kit planes in the world. In fact, Lancair has undergone more testing than many general aviation production aircraft. *Finite Element Analysis* (FEA) has been developed to the extent that it is without doubt the most definitive method of analyzing structures today. FEA analysis is likened to looking at an object through a microscope instead of a pair of binoculars. The Lancair wing structure was the first to undergo FEA. With this approach to analysis, a wing model is painstakingly entered into the computer where loads can then be applied. Spar, rib and skin profiles are entered and the resultant data will quite literally fill a room full of three ring binders. The first print out of the Lancair wing took over eleven solid hours to run! The structure is broken down into thousands of small sections or "nodes", each developing particular stress and strain patterns identified by the computer. With this data, the wing can be optimized.

To date, the wing, fuselage, engine mount and landing gear have undergone Finite Element Analysis. In addition we have load tested the wing to verify the 9G ultimate load capability. In 1987, the Swiss government load tested one of our kit Lancairs which was a requirement for local certification. As we had expected, the customer kit built Lancair actually tested out over 20% *higher* than our conservative in-house testing results. The Swiss officials are quoted to have said that "*the Lancair is the best kit plane they have ever seen*".

In addition, the Lancair has been dive tested to F.A.A. Part 23 standards with similar flutter checks. The Lancair has also been spin tested by an independent test pilot from Myriad Research Inc.

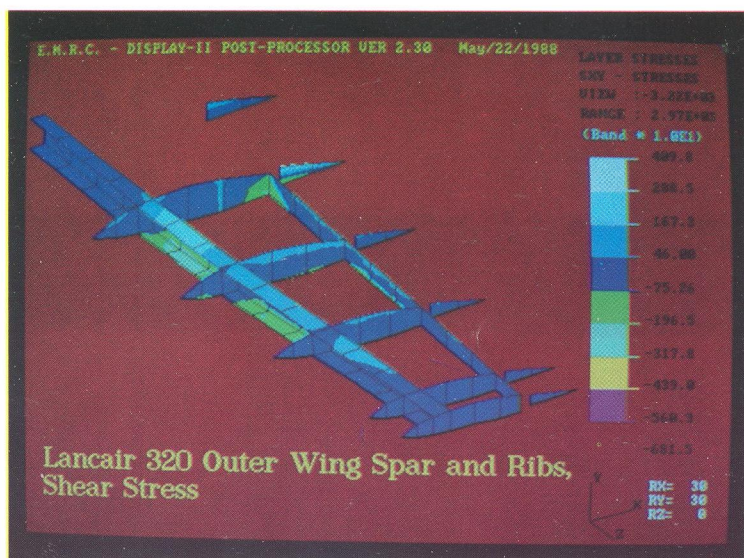

Extensive Finite Element Analysis has been conducted on major airframe components.

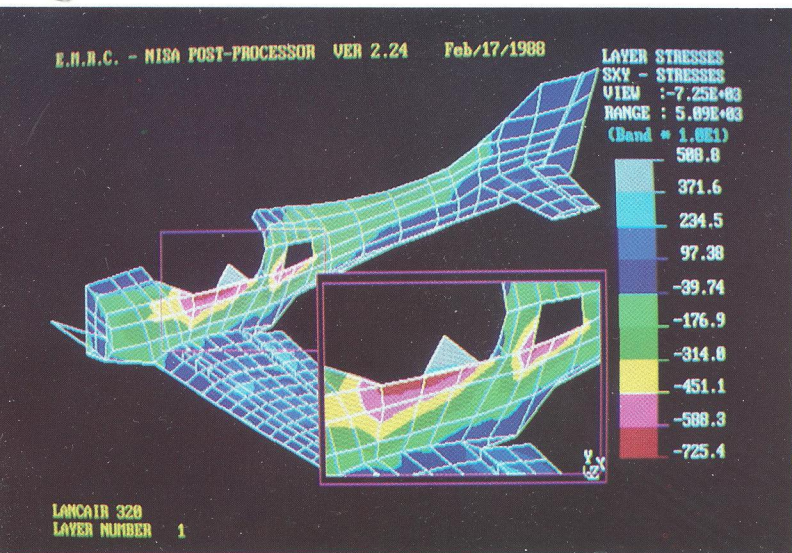

Finite Element Analysis of fuselage with longeron temporarily removed from calculations for test purposes.

"The Lancair's approach to materials use is unparalleled. . . it is the sign of the future".

Martin Hollmann, Aeronautical Engineer



LANCAIR 320

*"The Lancair looks as if it was extruded through man's mind
to be the ideal size and shape."*

Bud Davisson, Air Progress Magazine



"The aileron neutral spin is very predictable. The aircraft rotates about one half turn and the nose drops to about sixty degrees below the horizon. At this point the rotation slows, a slight "G" increase is felt and the airplane accelerates into an eighty degree nose down stable spin. The aileron neutral recovery is also very predictable. By relieving the back pressure, a recovery was always quickly achieved, typically within one quarter of a turn"

Dave Morss, test pilot, Myriad Research, Inc.

MATERIALS TESTING

Materials testing is very important and Neico Aviation has conducted many materials tests to validate our materials allowables. We have load tested to verify our prepreg E-glass and Unidirectional Graphite spar caps.



9G ultimate load strength

Also successfully load tested, to limit load, by the Swiss Government to validate rated strengths.

We have contracted with an independent testing lab in Los Angeles, Delsen Testing Laboratories, Inc., to perform coupon tests to verify our epoxy bonds. Since we use high temperature advanced composites, we tested our builder type, wet layup bonds at elevated temperatures as well. Results? Excellent. We design to a very conservative bond strength for all builder layups. Yet, even at $190^{\circ}\text{F} \pm 5^{\circ}\text{s}$ we still have epoxy bond line strengths that are in excess of 200% over required strength and these are only the *secondary* bonds! Our primary bond is the structural adhesive overlap joint created by our unique double joggle system. Lancair is the only kit plane to supply the much more expensive structural adhesive which has been tested in use on commercial aircraft for years. This adhesive alone provides a 300% safety margin, even at 190°F ! This all means that

the Lancair with its high temperature advanced composites and strong builder bond lines designed into the airframe, can tolerate colors other than plain white. We do however insist that all of our builders consult with us prior to painting their Lancairs any colors that are not light since other factors besides actual tint can affect heat absorption.

MATERIAL STRENGTH VALIDATIONS

Our design ultimate strength for the prepreg E-glass material is 33,000 psi for cross ply tensile strength. Once again, Delsen Testing Laboratories conducted strength tests of the prepreps. Results? Over 38,000 psi ultimate tensile strength or over 15%. Plus our design allowable strengths are established at a conservative 50% of ultimate for a built in safety factor of two.

In summary, the goal of Neico Aviation is to make the Lancair one of the best tested airframes on the kit plane market. Testing will always continue, and those results will always be disseminated to all of our builders. We are continuing to conduct testing in areas that few kit plane makers pursue such as lightning strike protection, materials burn protection, etc.

SERVICE BULLETIN UPDATES

Lancairs have accumulated thousands of flight hours already and as additional hours are logged, service related bulletins are compiled and sent to all builders. These bulletins are not something that you have to pay extra for or get free for just the first year, as with some kit makers, it is always sent without charge since we believe that such knowledge gained is invaluable, of utmost importance and should not be charged to our customers.

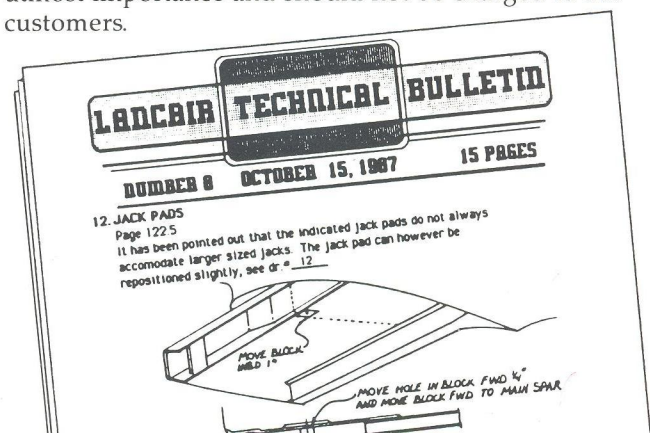

HIGH TEMPERATURE ADVANCED COMPOSITES

For the uninitiated, there are two large categories of composites: wet layup, room temperature systems which are usually polyester or vinylester based and high temperature, epoxy based systems. The wet layup systems are the common type found on speed boats, hot tubs and similar such items.

It is first quite interesting to note that virtually *all* composite airframe systems being developed today by the aerospace, commercial and general aviation manufacturers are utilizing *only* epoxy based, high temperature advanced composites. This is not coincidence, it is based on FAA part 23 standards and company philosophies which require airframe parts to possess traceability, uniformity, quality assurance and longevity.

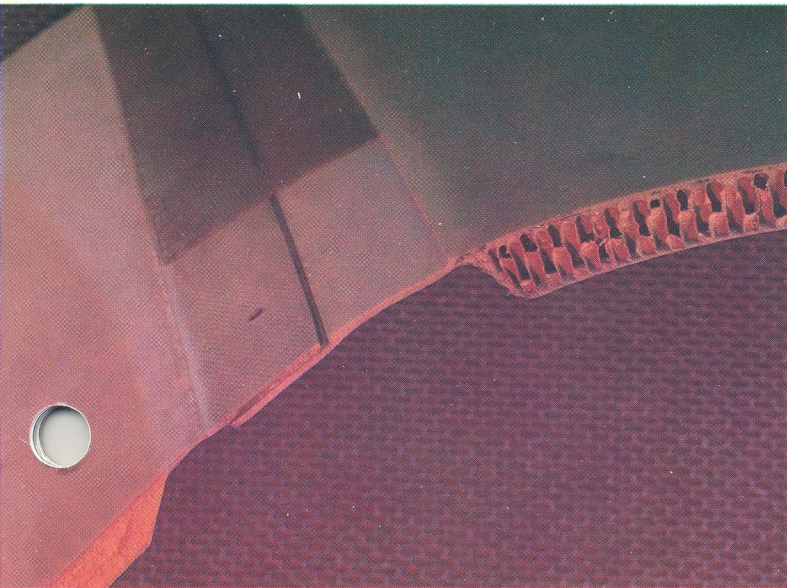

Lancair's high temperature advanced composites with our unique "Double Joggle" system.

Northrup, McDonnell Douglas, Rockwell International, Beechcraft, Airbus, Hughes, etc., etc., *all* use exclusively, epoxy based, high temperature advanced composites. There are only two reasons why anyone would not use advanced composites: materials cost and manufacturing costs, thus cost is the only real reason. Most of the general flying public, although well educated, are not exposed to the trade publications and technical papers concerning these remarkable composites. Thus the consumer is left with the inaccuracies generated by a promoter's personal motives and/or pure misinformation. That is why the consumer looking for an advanced high performance kit plane must be made aware of these materials and how the composite aviation industry has progressed beyond that of the old "boat technology" era.

Strength can be achieved with any medium, plywood, spruce, tube and rag, aluminum or composite thus strength is not the issue. The issues are: maximum strength to weight ratios, quality assurance, batch consistency, part longevity, thermal stability, surface fineness, fire retardation, etc. While all mediums offer some of these qualities, only epoxy based high temperature, advanced composites offer them all.

Epoxy based high temperature systems have actually made this composite medium possible for those companies with a real stake in the future. And as the knowledge filters down from the military and mega-corporations, the general aviation customers will eventually benefit, witness the Beechcraft Starship program. And now Lancair is proud to become not only the best selling kit plane in the world but also the first to make these advanced composites available. In fact it was these advanced composites that made the *Voyager* a reality. Without the 30% increase in strength to weight ratios offered by advanced composites, the *Voyager* could not have made its world record flight around the globe. It was made entirely out of epoxy based, high temperature advanced composites.

HIGH TEMPERATURE, EPOXY BASED ADVANCED COMPOSITE APPLICATIONS

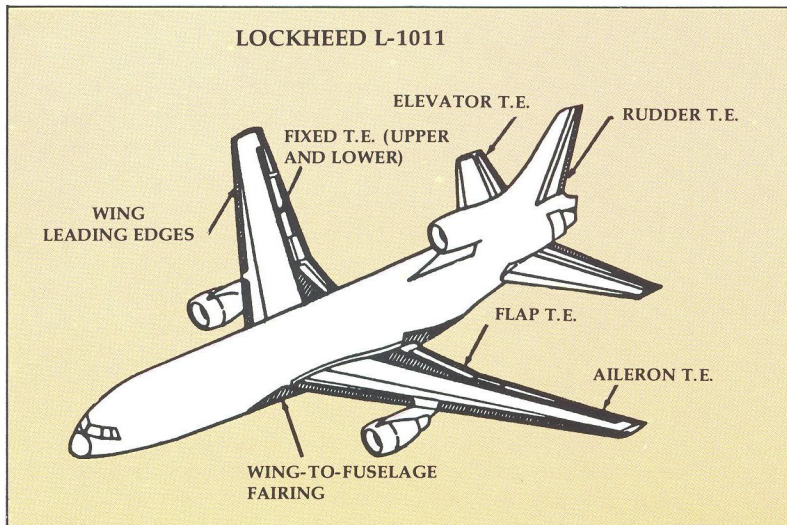

Virtually all commercial applications of composites use only high temperature, epoxy systems.

"Glasair was the third generation of composites and Lancair is the fourth."

Jack Cox, Editor Sport Aviation And Sportsman Pilot Magazines

STRENGTH TO WEIGHT

These advanced composites are factory "tower" coated where the resin is carefully measured with automated equipment and applied directly to the cloth. This assures uniform saturation through the weave and uniform volume of resin. The actual resin amount can be held to $\pm 2\%$ measured by weight. Also, with epoxy based, high temperature resins, the viscosity can be increased which produces much higher mechanical properties. With room temperature vinylesters, the viscosity must be kept low, with resultant strength loss, in order to hope to fully wet out the fabric plies every time the shop workers brush it on.

Advanced composites comprise the entire Lancair airframe and result in an airframe weight savings of as much as 30% over our competition's hand layup, room temperature produced airframe. That means less wing area required, less horse power required, less fuel consumed. . . purely better performance.

AIRBUS A-310 ADVANCED COMPOSITES

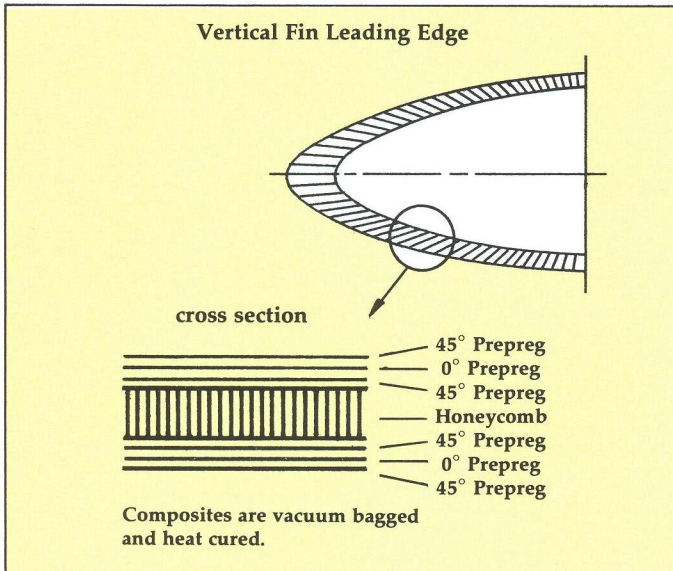

Typical laminates are composed of high temperature, epoxy based face sheets with Dupont Nomex® Honeycomb cores. Very similar to the Lancair systems.

QUALITY ASSURANCE

With factory applied resin systems such as with Lancair preregs, batch quality and volume is always consistent. That's something that just can not be guaranteed with a shop full of workers pouring resin into fuselage molds time after time. When we get a batch of pre-preg materials, they have already undergone rigorous inspections, there is no guess work, we know the resin is perfectly mixed, in the correct amount and perfectly blended into the fabric weave. That quality control demand is made by all of the military and commercial manufacturers and Neico Aviation agrees with this philosophy of guaranteed uniformity and total traceability.

THERMAL STABILITY

Thermal stability is perhaps one of the key differences between high temperature advanced composites and all other room temperature systems. Composites are strong, very strong but heat can be the enemy. The Tg (glass transition temperature) of polyesters and vinylesters is very low. So low that the only safe color available is white and even then extreme heat can generate temperatures close to the transition temperature of the materials. When this temperature is approached the strength will drop off substantially. This is another of the primary reasons why you will never see vinylester hand layup components on any of today's commercial transports or military planes.

Lancair's advanced composites are cured at $250^{\circ}\text{F} \pm 5^{\circ}\text{F}$ in calibrated ovens while under vacuum pressures of up to 2,000 lbs/sq.ft. The oven process is automated and carefully documented with calibrated equipment which records and monitors time, temperature and pressure. Every fifteen minutes the oven log is entered to record any fluctuations in temperatures or pressures. This log is permanently filed and cross referenced to each and every Lancair part, thus traceability is 100% and quality assurance is guaranteed. Autoclaves can also be used for this process, but within the commercial industry, more and more structural parts are being made with vacuum bagging techniques alone since 2,000 lbs/sq.ft. is sufficient pressure for virtually all structural components short of rocket nozzles.

In addition, and to insure a perfect bond of all face sheet plies and core materials, a very careful "ramp" time is established as the oven approaches critical temperature and as it cools down from thermal "set". This ramping insures a smooth and progressive "flow" of all resins. This works to eliminate trapped air voids which can be a common problem with wet layup systems. And that's another advantage of these advanced composites.



Fabrication is clean and precise unlike what you would see in a "wet layup" shop. Quality assurance is superior.

FLAME RESISTANT ADVANCED COMPOSITES

With our high temperature systems, only the finest materials are used on the Lancair airframe. The high temperature epoxy prepreg uses a flame resistant resin. This resin, when the flame is removed, will self extinguish. Vinylester will sustain a tremendous flame which is unacceptable on commercial industry standards and unacceptable to Neico Aviation as well.

Lancair core materials are the finest in the world: Dupont's Nomex[®] Honeycomb and High Temperature Divinycell[®]. Nomex[®] Honeycomb is used as a core material throughout the entire Lancair fuselage. The reasons are for formability to the many curves of the Lancair fuselage and also for increased compression strength and bending strength. Also, Nomex[®] Honeycomb will not support a flame and produces little to no smoke and no toxic gases. And that's very important for a fuselage / cabin area.

The wing and tail surfaces of the Lancair use HT (high temperature) Divinycell[®]. This is a PVC based core material and regarded as one of the finest in the world. It is also one of the few that will withstand the extreme temperatures of our curing cycle. It will also, of course, withstand high service temperatures. Low cost urethane foams, as used on other kit plane designs would literally melt on our oven floors.

A couple of our would be competitors have tried to make a feeble soap box stand on an old outdated issue of honeycomb water absorption. To the well informed there is no issue and has not been for years. A quick look at

what the leaders of the commercial industry are producing will convince anyone. Lancair is using, in many cases, identical ply schedules as those found on the DeHavilland Dash 7 and Dash 8 of Canada, the Boeing 767, the A-310 Airbus, McDonnell Douglas aircraft and virtually all other leaders in the composite field today. In fact the Boeing 767 outbd flaps employ *less prepreg* plys than used on the Lancair fuselage along with the similar Nomex honeycomb core. Thus the industry leaders attest to the fact that such topics are not of real concern and the problems reside only in the minds of those competitors who have fallen by the wayside of technology.

In addition to core materials and face sheets, our supplied bonding resins are also superior strength, low toxicity epoxies. They have many advantages over vinylesters and polyesters. First of all they are stronger, up to 30% stronger than vinylesters. Epoxies also have a much higher compressive strength. Our Safe-T-Poxy II is rated lowest on the toxicity scale and is considered safer than vinylester which possess very high amounts of such caustics as cobalt naphthalene, methyl-ethyl-ketone-peroxide and styrene. Cobalt naphthalene and MEKP when mixed together react violently and can spontaneously ignite, styrene absorbs humidity which can deteriorate a lamination and weaken bond integrity. Vinylester laminations are also *highly* flammable and not self extinguishing, a characteristic that obviously does not enhance safety.

Safe-T-Poxy II is low in styrene, thus controlling humidity is not an area of concern for our customers. As with any resin system though, adequate protection is essential for the homebuilder. Proper gloves must be worn and good positive ventilation must be available. Direct contact should always be avoided.

Shelf life is also very important to a homebuilder who may have resin sitting on the shelf for months. The shelf life of our Safe-T-Poxy II is over one year. It has been tested after three years and demonstrated *no* loss of strength. On the other hand, a vinylester resin shelf life is only 4-6 months. Thus when you take delivery of your full airframe kit, if it uses vinylester, you might end up throwing away a portion of your resin if you receive it all at once or you'll have to pay extra shipping to receive it in small enough allotments to avoid exceeding its short shelf life. But with your Lancair, you can receive all the resin with your kit and be able to use it thus saving money and aggravation.



Typical vinylester laminate as used on many kit planes is extremely flammable.

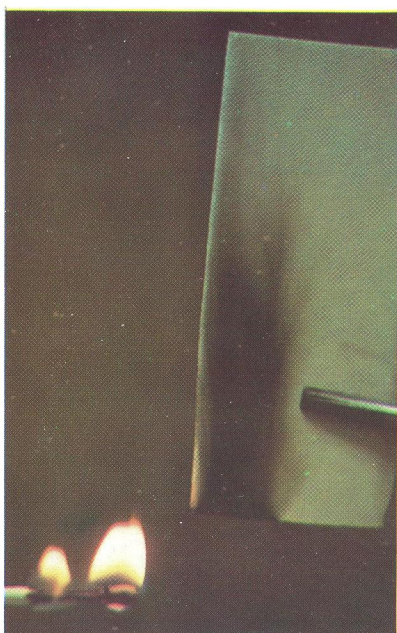

Lancair's epoxy based, advanced composites will not sustain a flame.

ASSEMBLY OVERVIEW

FUSELAGE ASSEMBLY

The fuselage is comprised of two main pieces, a left and a right. A third "belly pan" will be added later in conjunction with the center "stub wing" section. These fuselage halves have our unique *matched overlap, double joggle system* for alignment. Simply trim the pieces to the standard one inch joggle length and mate the two pieces together. Unlike other composite kits that have an awkward "butt joint", your Lancair halves can be clipped together in literally twenty minutes. The preformed "joggles" are cleaned, sanded lightly and coated with high strength structural adhesive. Common pop rivets are used as a clamping device to hold the seams tightly together until the adhesive cures after which time the pop rivets are simply drilled out! As a back up and to seal the joint area, the area still has what now will appear to be a single wide joggled area which is below contour surface. This 2" wide joggle will be cleaned, lightly sanded and have two plies of bidirectional fiberglass "tapes" applied. One "tape" will also be applied to the inner side. This overall approach to bonding duplication helps to make the Lancair incredibly strong.

With the fuselage halves now bonded together, all of which is accomplished in about two hours total time, you're ready to add some bulkheads and stiffeners. First the firewall bulkhead is added. This bulkhead is pre-marked for you, simply trim to size and bond into position along the forward marked joggle. Simple. Next longeron stiffeners are added, these stiffeners provide

tremendous stiffness to the Lancair cabin sidewalls and are installed in about an hour. Add the rollover bulkhead and baggage bulkhead and you've now got a very rigid fuselage structure. No jigs were required, only a carpenter's level and three common saw horses! No other kit maker on the market can claim that kind of assembly speed for a fuselage!

Also, the fuselage remains fully accessible for all future systems installation. No crawling back into the tail cone to add fiberglass tapes as with other kit designs. The entire cockpit area and the entire area from the instrument panel location to the firewall *remain fully open and accessible* until the last cable and wire are installed! This feature alone will save you possibly hundreds of hours! The tail cone area also remains open until all systems are installed and only then will the vertical stabilizer halves be "closed out". This includes all your antenna installation requirements before close out as well!

And you'll rest more comfortably knowing that our prepreg fuselage is flame resistant. The Nomex Honeycomb core material meets stringent government smoke, toxicity and flammability standards, it is flame resistant and self extinguishing! That's again something our competition can not offer with their urethane foam/vinylester components and is a serious safety issue. It's also nice to know that pound for pound, our Nomex Honeycomb fuselage core has *more* compressive strength than steel!

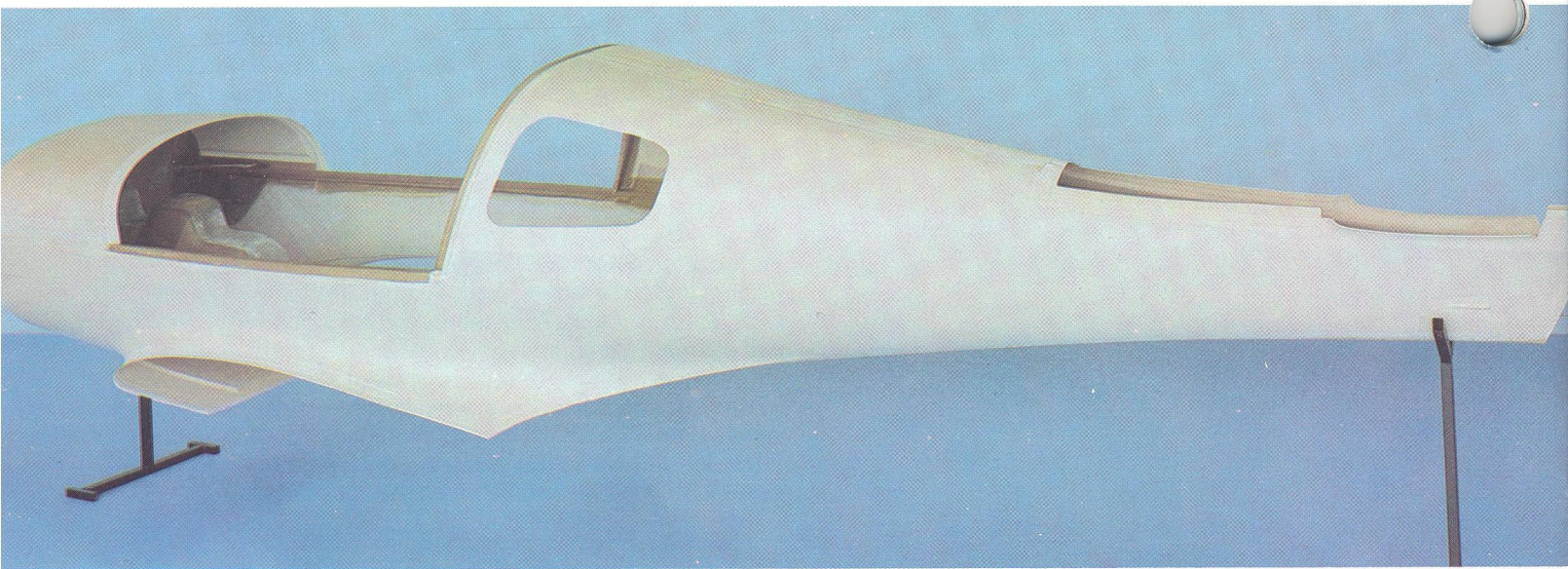

Fuselage shells with removeable forward deck. Note the double joggle and integral wing fillets.

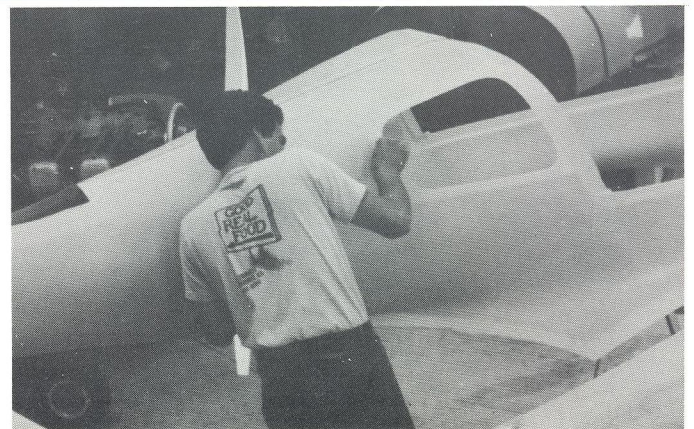

WING ASSEMBLY

The unique Lancair wing is comprised of three major sections. The center "stub wing" section which is permanently attached to the fuselage allows beautifully sculptured and aerodynamically clean wing to fuselage fillets. These fillets are fully premolded and are an integral part of the fuselage halves.

The two outboard wing sections are always fully removeable! This is a tremendous convenience feature for trailering to the airport.

The wing is built from the fuselage outward in the inverted position. Mr. Martin Hollmann, our engineer, insisted on this inverted approach which is opposite to our competition's approach. From an engineering standpoint, the reason one assembles the wing in an inverted manner is to allow the bonding techniques to work in harmony with the aerodynamic load pressures during flight. During 99% of your flight, the wing will see low pressure on the upper surface and high pressure on the lower surface thus forming "lift". Therefore, bonds tend to see tension on top and compression on the bottom and that is how we assemble our Lancair wings, with strong, wide tension bonds on the inside upper surfaces and compression bonds on the lower surfaces. Many other kit plane wings are built exactly opposite to these known load paths.

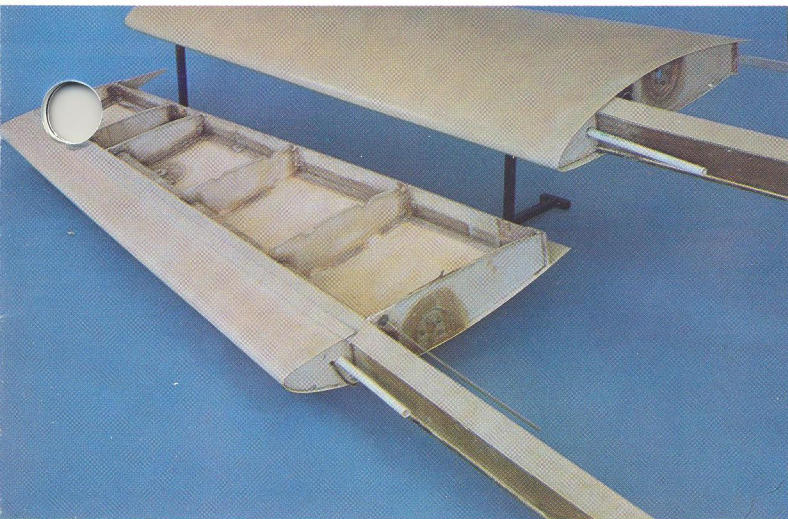

Lancair's continuous "D" section wing and full size rib templates all make assembly easy.

The inboard bays carry fuel, outboard fuel bays are optional.

There are two very simple "cradles" that establish the proper incidence of the wing. Basically, the upper wing sections are layed into these plywood cradles and all ribs are dropped into position. A fuel bay is built into the outboard wing sections. This bay area can be tailored to your individual needs. We encourage our builders to be "realistic" about how much fuel to build in since the wing sections are capable of holding a great deal of fuel, more than is generally practical. Standard fuel on the 320 is 42-43 gallons which provides in itself more than 1100 miles of range. With converting the outboard wing tip rib section to a fuel bay, range can be extended to about 1,500 miles.

UNIQUE CONTINUOUS "D" SECTION FOR SAFETY

As previously highlighted, one unique aspect of the Lancair wing design is the continuous "D" section. This complete forward 25% of the wing is one *continuous* premolded piece and is an integral part of the upper wing skin itself. This totally eliminates any builder bond lines and leading edge butt joints on what is one of the most critical areas of any aircraft thus safety is again enhanced. Other makers use these wing leading edge butt joints but we at Neico Aviation do not feel that such critical areas should be left to that type of bonding procedure.

All control systems are installed before the lower wing skin "close out" is made. All systems are fully serviceable and replaceable. Only one inspection hole per wing is required.

After the wings are "framed" up along with flaps and ailerons, the outboard sections can be quickly removed with all final finishing conducted apart from the fuselage. This helps tremendously to free up valuable work space in the typical two car garage where these planes are commonly built. The completed outboard wing sections will typically weigh less than 60 lbs, making them very easy to handle.

The landing gear is installed into the stub wing section, generally prior to the outboard wing assembly. This allows for the gear to be fully and permanently installed onto the fuselage and stub wing. Wing removal does not require any gear disconnections, either mechanical or hydraulic. The result is extremely easy trailering. With the outboard wings sections quickly removed, the fuselage and stub wing remain fully on the gear and the overall width is within the common 8'6" trailering limit.

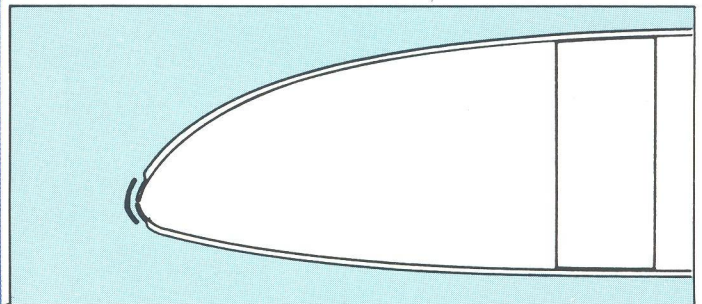

Common leading edge "butt" joint on wing. Assembly is difficult and critical.

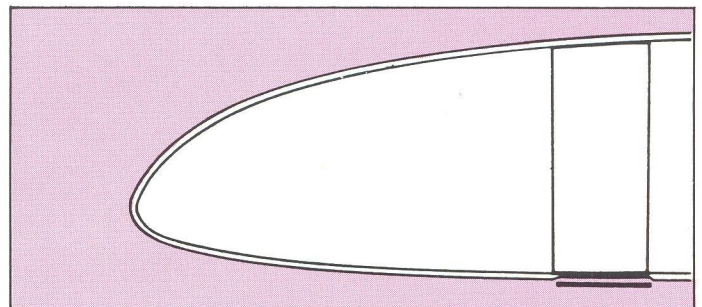

Lancair's unique "continuous D section" offers assured strength for safety.

TAIL GROUP

The Lancair tail group is comprised of primarily upper/lower or left/right premolded skins. These sections are assembled with an internal rib structure which is very simple and straight forward. All control surfaces are 100% mass balanced with supplied custom lead weights. The ailerons, flaps and elevators use Mil-spec extruded hinge stock for pivoting on stainless steel pins. The custom rolled skins create a tight fairing for low hinge line drag. The rudder uses center line pivot hinges and also fairs in smoothly. All horizontal stabilizer fillets are preformed into the component parts, just like with the wing fillets. Once again, we're making it easy for you.

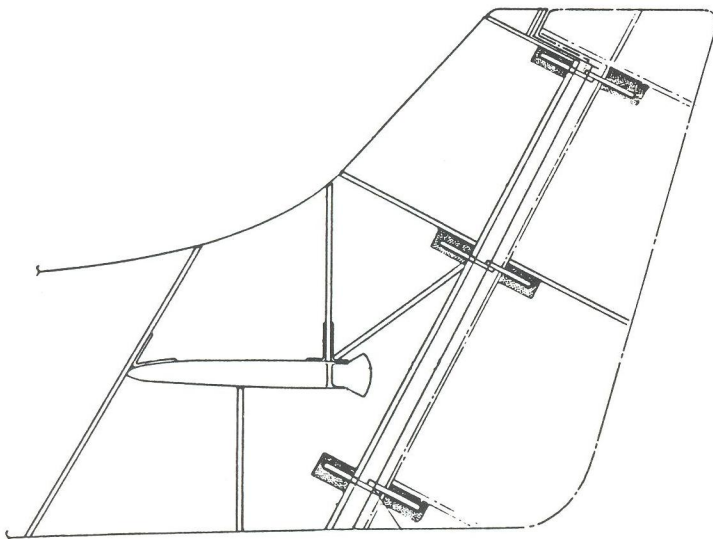
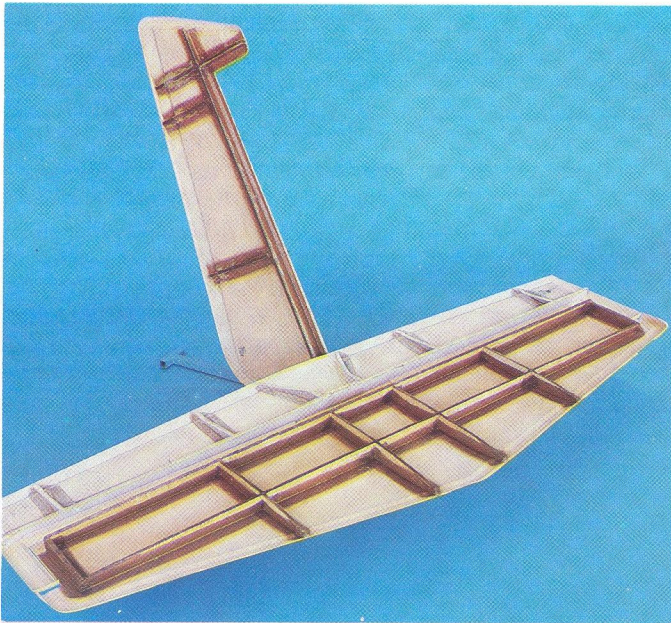

ASSEMBLY MANUAL

Our assembly manual will take you through each phase of assembly with easy step by step instructions. It is written in everyday language and designed from page one to be understood by even the most novice builder. A forward glossary illustrates all pertinent "AN" hardware and defines typically used terms and expressions. The plans are further enhanced and made easy to follow by a generous addition of simple, non-technical, three dimensional drawings to "show you" just what you'll be doing. We know that engineering type, cross section drawings can often result in making a simple task appear difficult and confusing so those types of drawings are kept to a minimum. Also, many full size templates are supplied in blueprint form for ribs, bulkheads, consoles, gear door cutouts, etc. Simply trace them out onto your bulkhead materials and cut to size, a final fit is achieved during the closeout process.

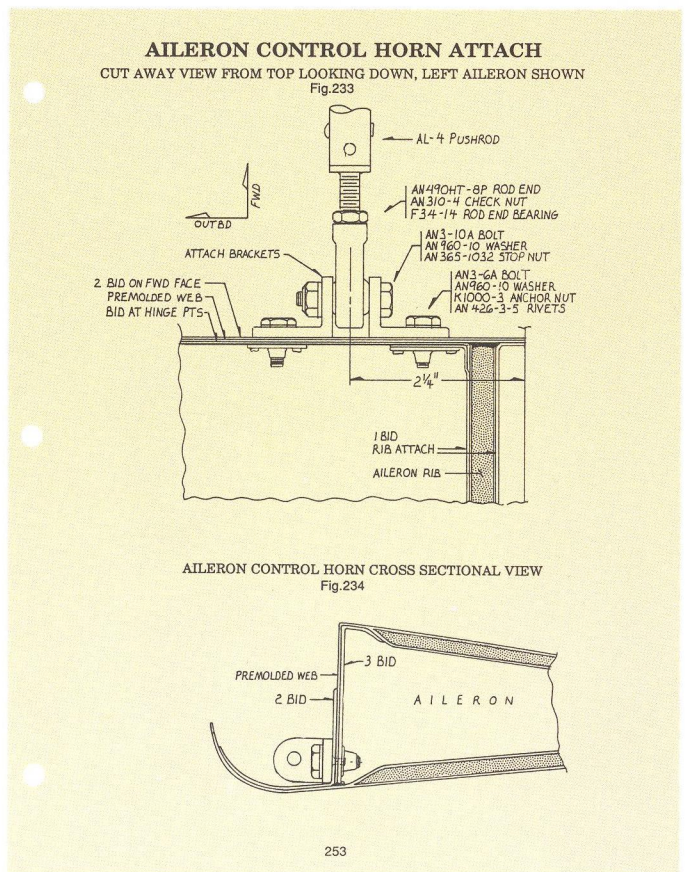

Plans are easy to follow
and very straightforward

TECHNICAL ASSISTANCE

We also know that you will likely have additional questions and we welcome them. We want your building experience to be a pleasurable one and the final product, your own Lancair, to reflect our high standards. So if questions arise, one of our technical staff is only a phone call away.

TEST FLIGHTS & VISITS

We do not encourage any of our builders to go charging off into the blue in their new Lancair without some previous Lancair "stick time". When you have completed your Lancair, call us and we'll arrange a time when you can come to fly one of our company planes. We'll give you some air time and shoot a few landing so you'll be as ready for that first flight as your plane is. Also, depending on our availability and scheduling, we often travel to our builder's completed aircraft to make that final inspection. You can't have too many eyes when it's preflight inspection time and we at Neicc Aviation know how to make that inspection best. The most we might ask of you, the builder, is an out of pocket cost sharing of our inspection visit. We also *highly* recommend all customers to join the a local chapter of the E.A.A. (Experimental Aircraft Association) headquartered in Oshkosh, WI. There are hundreds of chapters all around the world.

We also have familiarization flights available for those interested in purchasing a Lancair. Please call to discuss this and arrange for a visit. Our planes are often out to races or airshows so do call in advance.

LICENSING & REGISTRATION

All kit planes operate under the FAA guidelines titled "amateur built, experimental". This category is not too unlike the standard category with some pointed exceptions. First of all, you can expect a one time visit by the FAA or their designated representative to make an airframe inspection for airworthiness. This is a straight forward affair where a general airframe inspection is made. They will check for proper installations such as cotter keys where necessary, free, unrestricted and complete control travel, proper placarding, etc. Inspections generally take about an hour and depending on your location in the U.S., an appointment may require several weeks lead time. In busy, well staffed areas, advanced notice often requires just a couple of weeks. Once approval has been issued, you will be required to fly typically 40 hours within a predesignated test area which has a 25 mile radius from your chosen airport. This airport must be approved which generally means that it must be outside of densely populated areas. After those test hours are completed, you will typically sign off your own log books and move in to the final phase of your airworthiness issuance which then allows you to leave your test area. The prime remaining difference is that your plane can not be used for hire. You will also be able to apply for and receive a "special repairman's certificate". This allows *you* to conduct your own annuals on your kitplane. And that is a tremendous advantage and cost savings.

WORK AREA REQUIRED

This illustrates yet another *tremendous* Lancair advantage over our nearest competition. With many kit planes on the market, work space requirements are significant. Since a high percentage of our customers are assembling in their garages, a one piece wing would present a *major* problem.

The "standard" two car garage measures approximately 20' x 20'. Thus a 24 foot one piece wing would be nearly impossible to assemble in your standard two car garage. The only choice left would be to rent additional larger space somewhere which would be costly and very inconvenient.

Your Lancair kit, with removeable outboard wing panels, is *very* well suited to assembly in a standard two car garage. We've even had builders working in a *one* car garage although you would definitely outgrow that space at various times during assembly. These outboard wing sections can be built up from the fuselage, one at a time thus occupying minimal space. The outboard wing panels weigh just 60 lbs and can be moved around easily.

Approximately 70% of your time will be devoted to the fuselage, tail and related installations. For this, your Lancair will nicely rest on its complete gear, therefore it is easily rolled around and occupies about the same space as one mid-sized car.

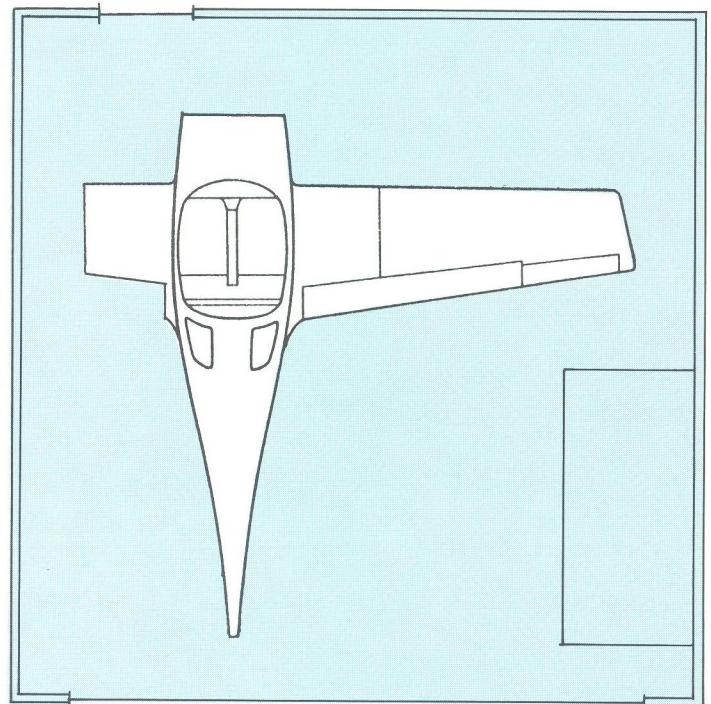

STANDARD 20' x 20' GARAGE

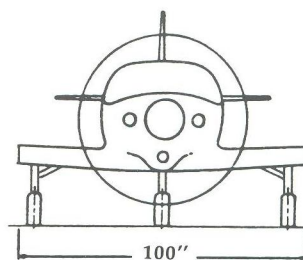

Lancair with outboard wing sections removed

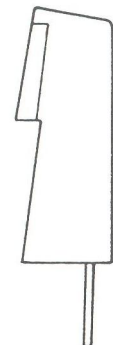

ENGINE CHOICES AVAILABLE

With any of our models, you'll have a wide choice of engines that will work *without* modification. With many kit planes on the market, engine choices are few without costly modifications to allow them to fit into the cowl. With Lancair, your available, unmodified choices are greater.

Lancair 235

The Lancair 235's will take virtually any Lycoming 0-235 engine. The most commonly available in the U.S. are the series "C" and "L" types. The 0-235-L series is generally considered superior due primarily to their greater horsepower. The "L" series engines all have dynafocal mounts, the "C" series engines use the older straight mount. The dynafocal is considered superior since it dampens vibration better. Also, the "I" series engines are higher in h.p. 115-118 h.p. vs. the "C" series 100-115 h.p. A standard starter will work well, however some of the newer, aftermarket starters will work best and save many precious pounds.

Also, with this airframe, the Continental 0-200 engine can be installed. With this lower h.p. engine choice, airframe weights must be closely monitored during assembly. We generally recommend the larger Lycoming 0-235 engines for this airframe. The only difference structurally between the two is firewall forward, this must be specified when ordering.

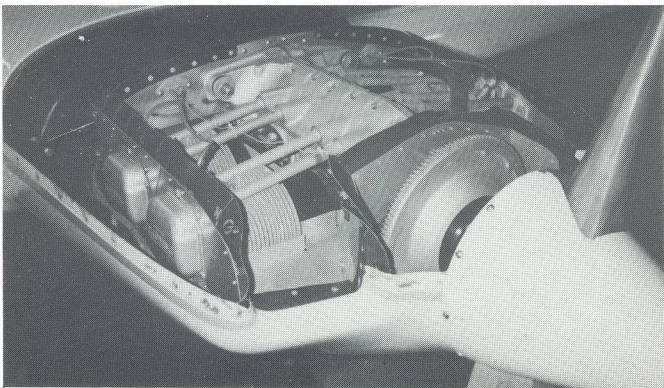

Lancair 320

The new 320 model has quickly become our best seller. It offers minimal weight increase, additional room and exceptional performance with constant speed propeller capability. Once again, your Lancair 320 will accept nearly all Lycoming 0-320 engines. The "H" model engine, which is generally considered the least desirable model, currently will *not* fit the Lancair.

There are two basic areas of differentiation with the 0-320's.

1.) One regards the mount type, either conical or dynafocal. All earlier 320's were "conical" meaning the four engine mounting bolts locate "parallel" to the crankshaft. Later model 320's switched to a "dynafocal" mount. The four engine mount bolts all angle inward to a point at the engine's center. These bolts have a *dynamic focal point* on the engine, thus the term "dynafocal" mount. The dynafocal mount is considered to be superior in that it dampens out engine vibration better than the earlier mounts.

And to complicate matters a little more, there are two different *angles* used for the dynafocal type engines. We

can however supply mounts for either the "Type 1" which is the higher angle and most common or the less common "Type 2" as used on twin Comanches. The type 1 is preferred.

Your Lancair 320 will accept any of the above engine mount types. Of course you will have to specify which type.

Many of our customers really don't know which type of engine mount they will be needing since they often have not purchased their engine when they take delivery of their Lancair kit. For this reason, many builders choose to postpone their engine mount selection and delivery until they have decided on a specific engine. As always, someone on our technical staff can assist you regarding these and other decision issues.

2.) The second engine issue regards the location of the carburetor. You'll be very pleased to know that the Lancair 320 will accept either of the two carburetor locations. Many high performance kit planes such as Glasairs can *not* accept the earlier type "aft" mounted carburetor. You would then be denied this very large market of available engine choices or be forced to purchase a late model oil sump and a new set of intake runners. Those are very expensive items costing hundreds of dollars each. Once again, your Lancair will accept either of these carburetor locations thus saving you money and expanding your available engine choices.

3.) The third issue is fuel injection. Fuel injection can be used on the Lancair 320. Unlike the other engine choices, modification is likely. The most common IO-320 engine attaches the injector body on the aft vertical face of the oil sump. This is unacceptable due to engine mount interference. A front mounted injector is required. This type of sump is rather difficult to locate and therefore we have modified the aft mounting sump to relocate the injector on the forward face. This conversion to the existing sump will cost approximately \$400.00. Our first company Lancair 320 uses this system. If you choose fuel injection, simply contact one of our technical representatives for assistance in making this conversion.

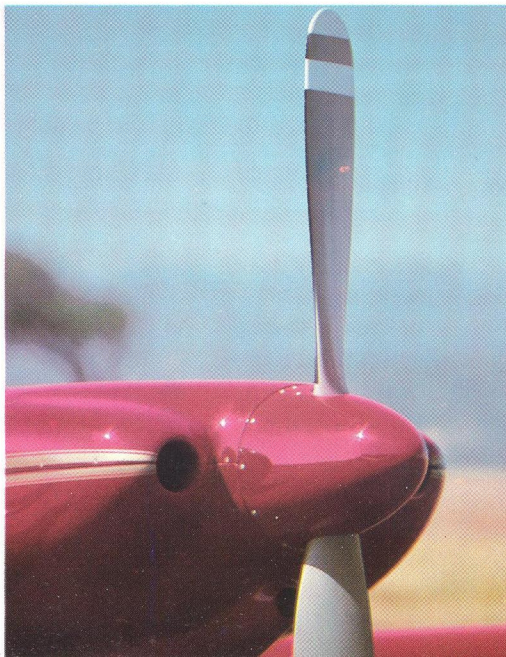

*"The 320 is a sensational airplane,
smooth controls with positive stability"*

Dave Martin, Kitplanes Magazine

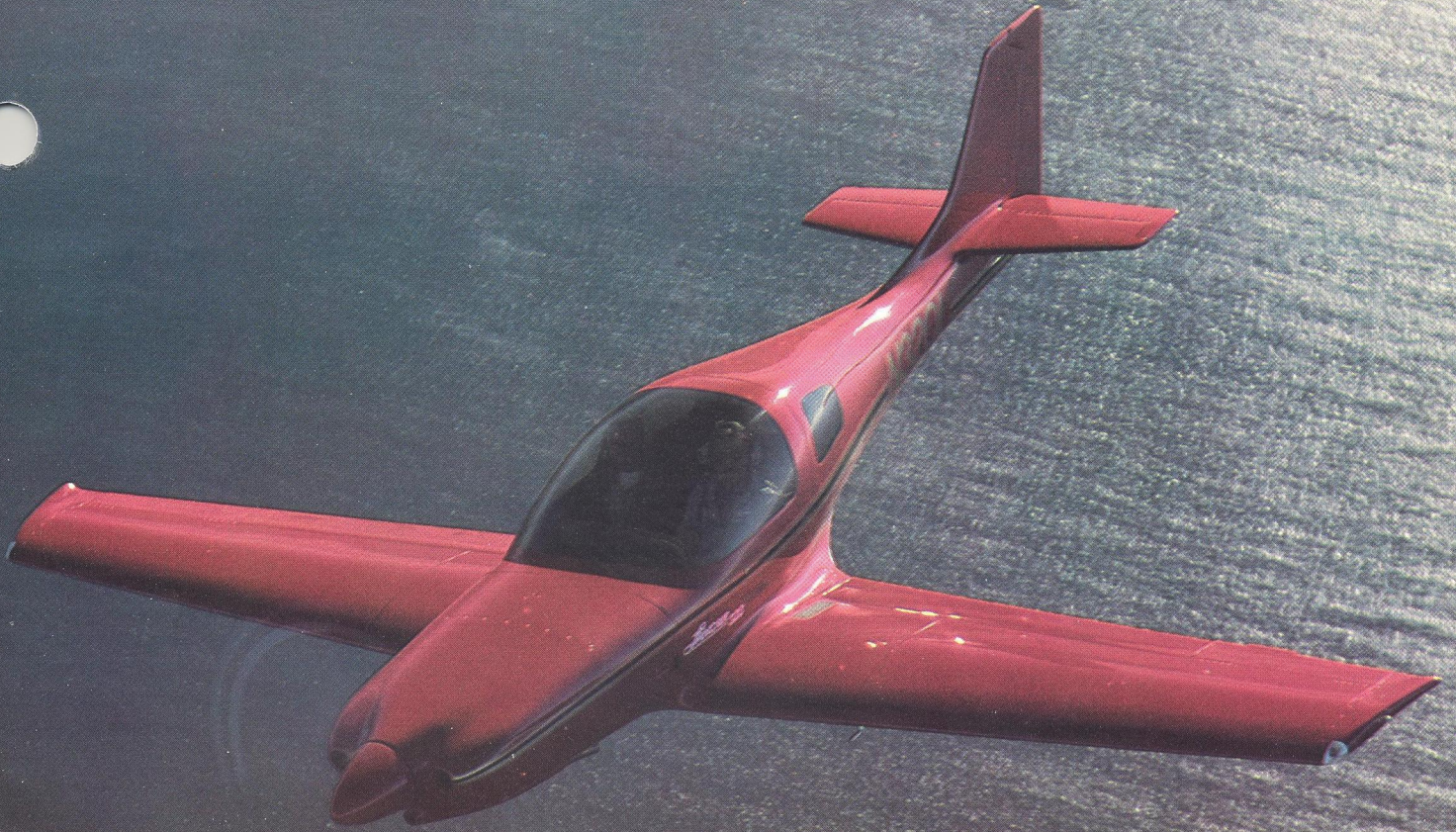

LANCAIR[®]

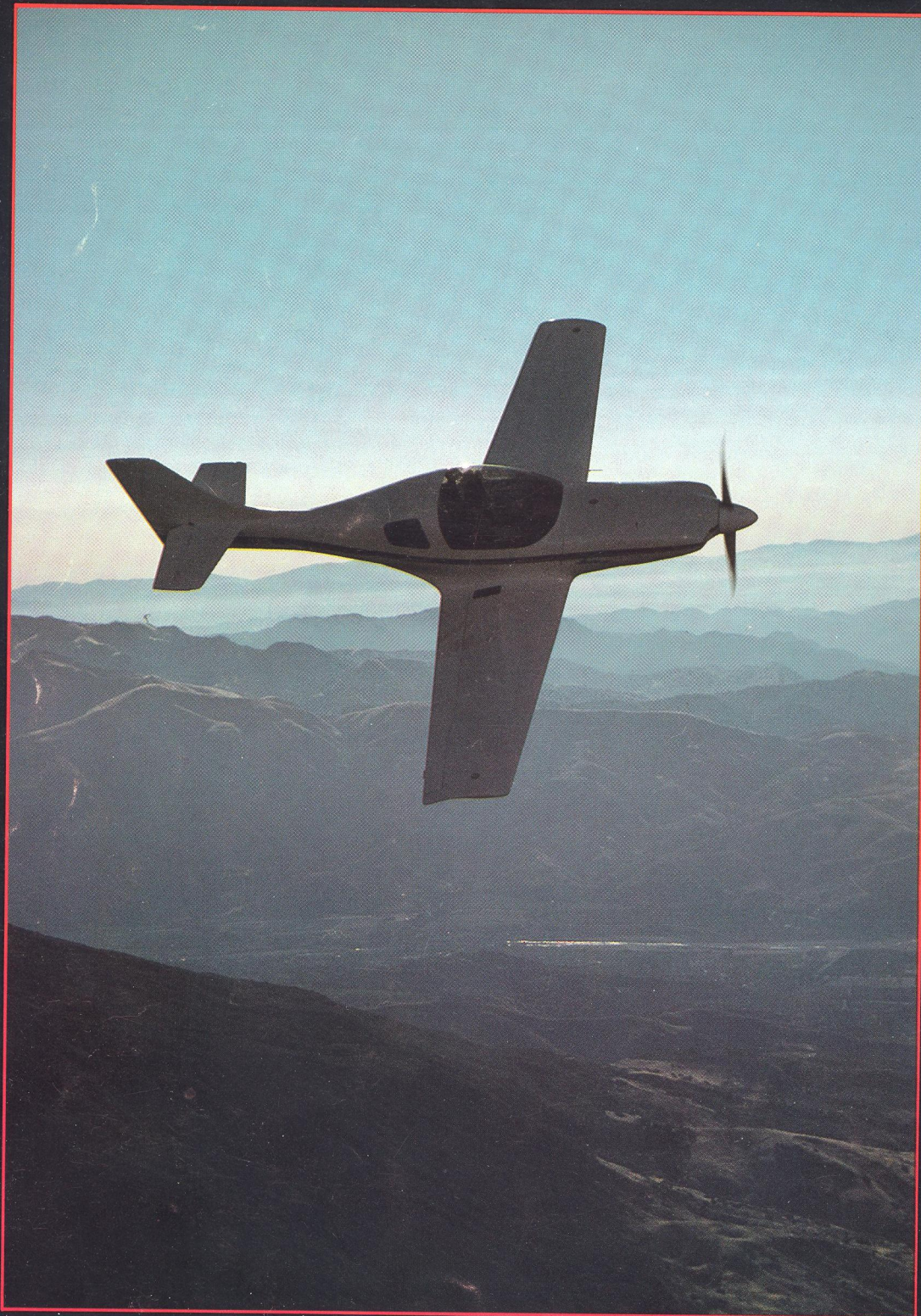

NEICO AVIATION INC.

403 S. Ojai St., Santa Paula, CA 93060 (805) 933-2747 Fax 805-933-2093

©1988 Neico Aviation Inc.